



Loops and Switches



Loops and Switches Pre-Quiz

1. What kind of blocks are these?

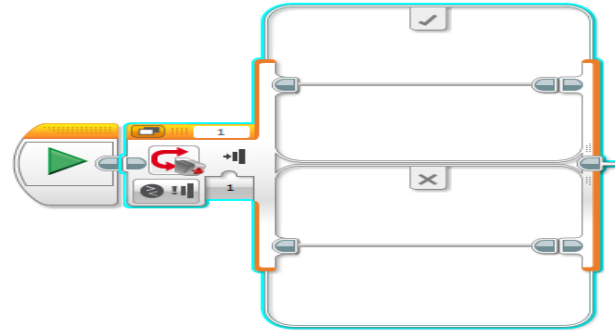
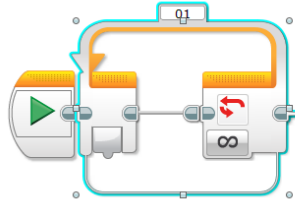

2. Name two kinds of controls that can be specified to determine how long a loop repeats.

3. Give an example of a program you could write that would use a switch.

Loops and Switches Pre-Quiz **Answers**

1. What kind of blocks are these?

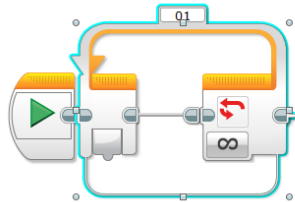

loop

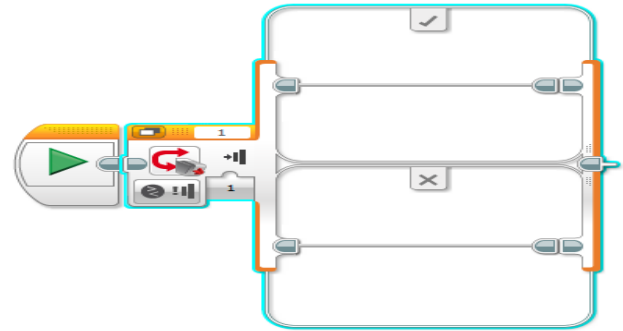

switch

2. Name two kinds of controls that can be specified to determine how long a loop repeats.

Any two of these: "Forever" (a never-ending loop), any sensor, "count" (tell the loop to repeat, for example, 5 times), "time" (tell the loop to repeat, for example, 1 minute), logic

3. Give an example of a program you could write that would use a switch.

Example answer: While the touch sensor is pressed, go forward; otherwise, move backwards.

What are loops and switches?

(50 minutes)

Objective

Loops and switches are two of the most important tools used in programming.

- **Loops** allow us to repeat segments of a program indefinitely or until some condition is met
- **Switches** allow a program to respond differently to different conditions

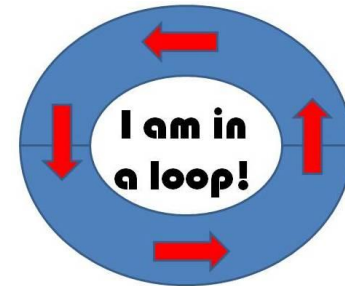

In today's lesson, we:

- Investigate how loops and switches work
- Learn how to use loops and switches when we program using the LEGO MINDSTORMS EV3 software
- Learn to use switches and loops in unison to expand the functions of the programs we will make

Loops: What Are They?

- In programming, a *loop* is an operator that allows us to repeat a set of commands indefinitely.
- In many factories, a machine performs the same simple task thousands of times in a day
- Watch a video clip of an assembly machine
www.youtube.com/watch?v=AwJflkd6Y_o (1:41 minutes)
- As a programmer, you don't want to have to copy instructions for repeating that same simple task thousands of times...
- So, instead, you write commands for the simple task **once**, and then enclose those commands **in a loop**, which can be repeated as many times as you want.

Programming with Loops

Suppose we want to make a robot move once around in a square.

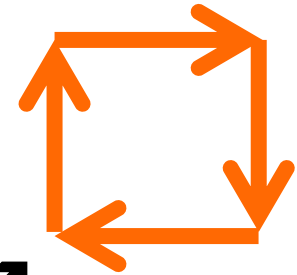

start/stop at this corner ↗

A program to do that has 8 blocks and would look like this:



Programming with Loops (continued)

- Programming this task becomes a lot easier if you use “loops.”
- Notice that the 8 commands we would use to do this (forward, right, forward, right, forward, right, forward, right) are really just the same 2 commands repeated 4 times
- So. what we really want to program is simply:
Repeat (1. go forward; 2. turn right) 4 times.
- In the LEGOMINDSTORMS EV3 software, the loop block icon looks like this →
- Drag this block down to the main line of your program as shown:

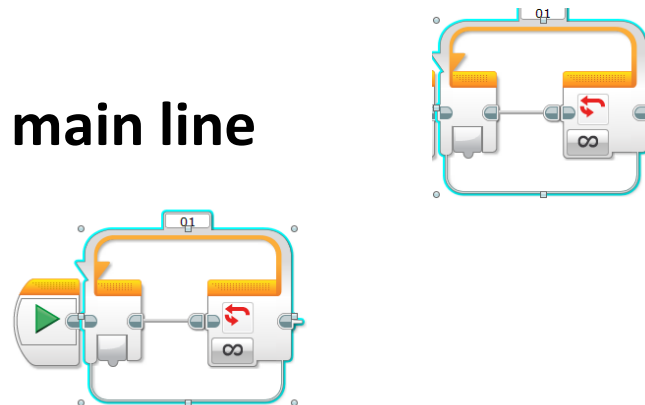
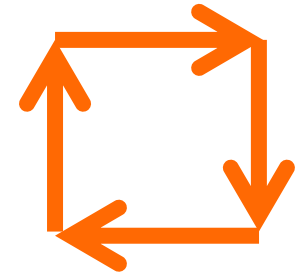

Programming with Loops (continued)

- When you highlight the loop block, notice the drop-down menu next to “Control.”
- The **Control options** enable you to tell a robot **how long** to keep looping the commands inside the loop.
- Selecting “**Unlimited**” repeats those commands indefinitely.
- Selecting “**Sensor**” repeats those commands until a sensor detects a stimulus (for example, until the touch sensor is pressed).
- Selecting “**Time**” repeats those commands until a certain amount of time has expired (for example, 5 minutes).

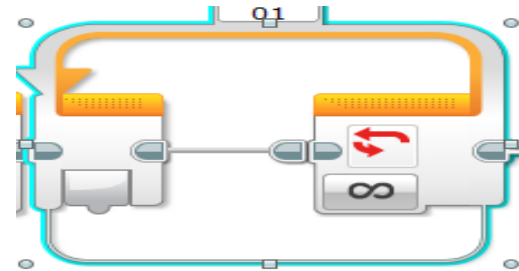

Programming with Loops (continued)

- Selecting “**Count**” repeats those commands some specific number of times.
- We won’t discuss selecting “**Logic**” at this time, because it is a bit too complicated for our application.
- *In this case, what do we choose?* Since we want the commands (go forward, turn right) to be repeated 4 times, we select “**Count**” and set “count” to 4.

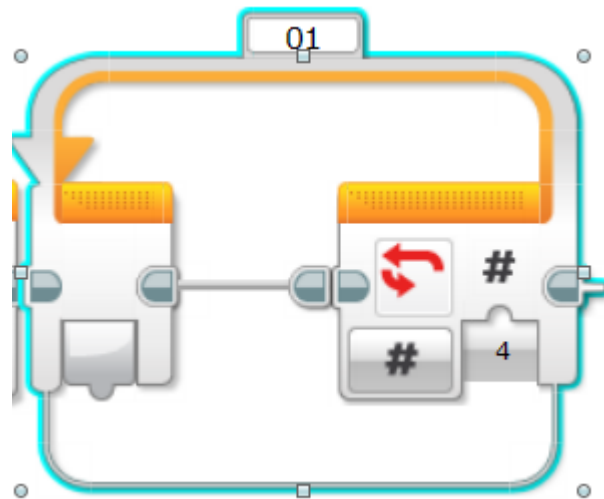

Programming with Loops (continued)

- Next, we need to drag the commands we want to be repeated **INSIDE** the loop.
- The final program looks like this: ↓

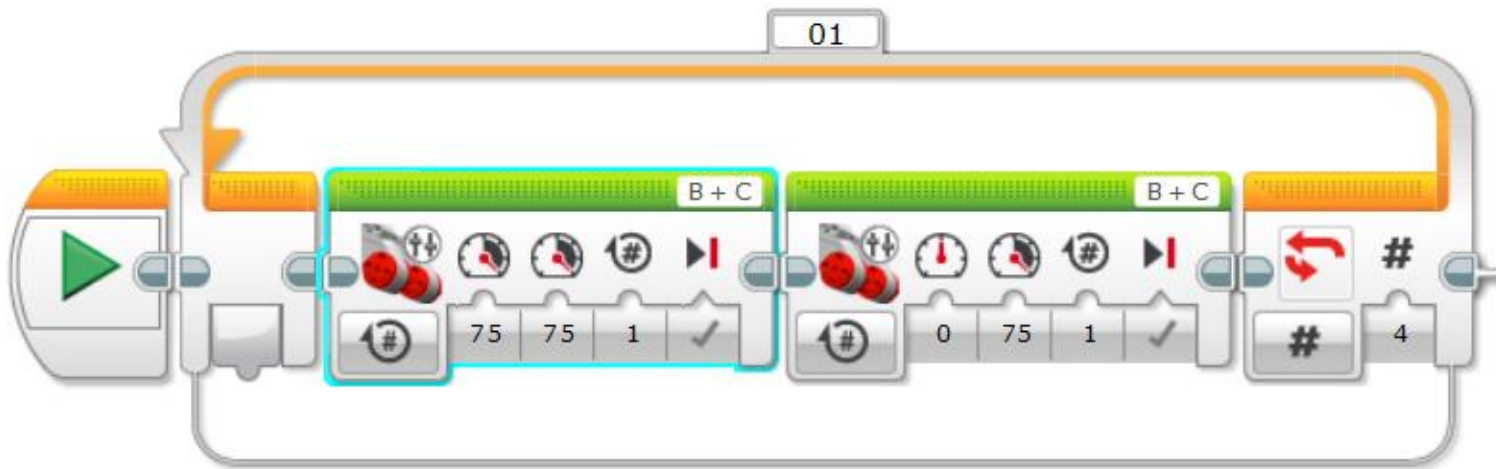

- Notice that instead of 8 blocks, we only need 2 blocks, surrounded by a loop.

Mini-Activity 1

Do This:

Fill out Part 2 of the worksheet.

Then program the robot to:

- Go forward until it hits a wall, then back up one rotation and turn left**
- Repeat the loop four times**
- Then stop**

Mini-Activity 1 Programming Solution



(continued)

Mini-Activity 1 Programming Solution

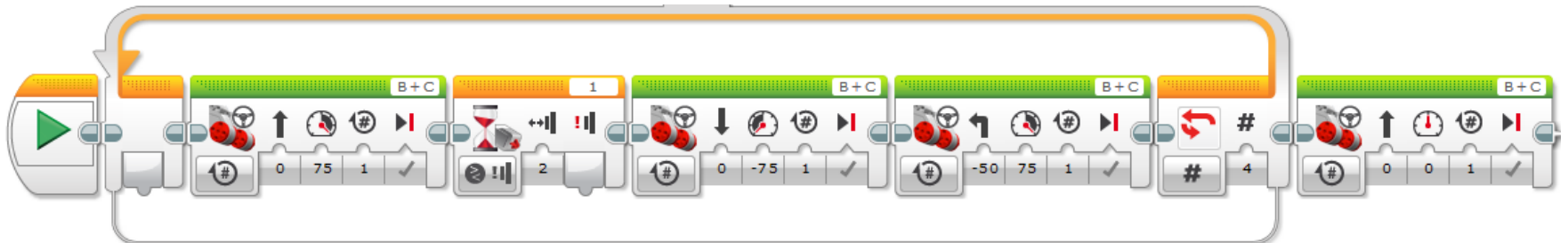

4



5

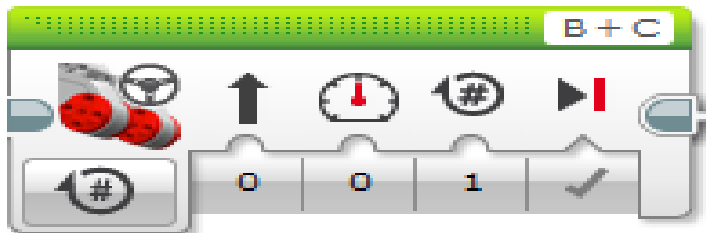

Day 2: What Is a Switch?

- In programming, a switch is an object that gives different commands depending on which state it is in.
- A light switch for example, has 2 states: **up** and **down**.



- When the light switch is in the “**up**” position, the switch directs the light it controls to **turn on**.
- When the light switch is in the “**down**” position, the switch directs the light it controls to **turn off**.

Programming with Switches

Suppose we want to program a robot to end up exactly 24 inches from a wall no matter where it starts.

- This means that the robot will always be in one of two states:
 1. **closer** than 24 inches to the wall
 - or
 2. **farther** than 24 inches from the wall
- We can best deal with this situation by using a switch.
- To do this, click on the **switch icon**:

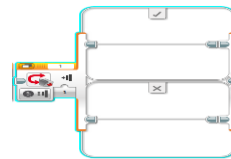

and drag it down to the program line.

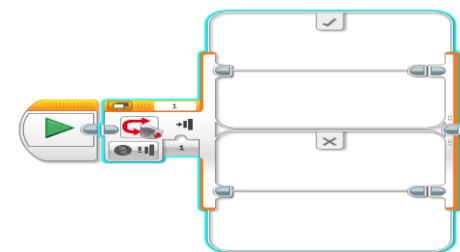

Programming with Switches (continued)

- When you highlight the switch block, notice that you can **indicate the sensor used**.
- In this case, we are interested in how far away the robot is from the wall, so we select the ultrasonic sensor from the drop-down menu.
- Because we want the state of the switch to depend on the distance the robot is initially away from the wall, we also need to **set the distance** to 24 inches.

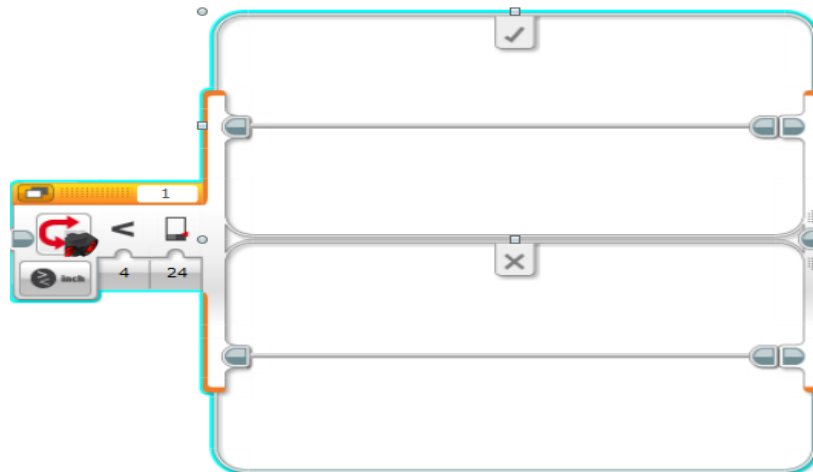

Programming with Switches (continued)

- If the condition specified is **satisfied**, the program will execute the commands in the **top half of the switch**.
- This means the robot is less than 24 inches from the wall and we need the robot to back up until it is at least 24 inches away from the wall.
- We can achieve this by using a backward move block with unlimited duration followed by a wait block as shown below.

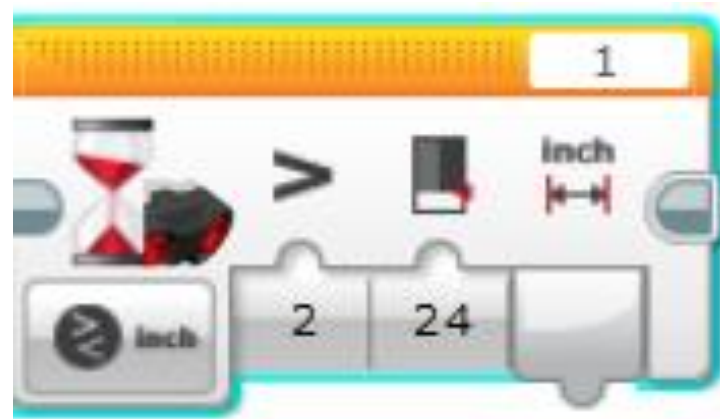
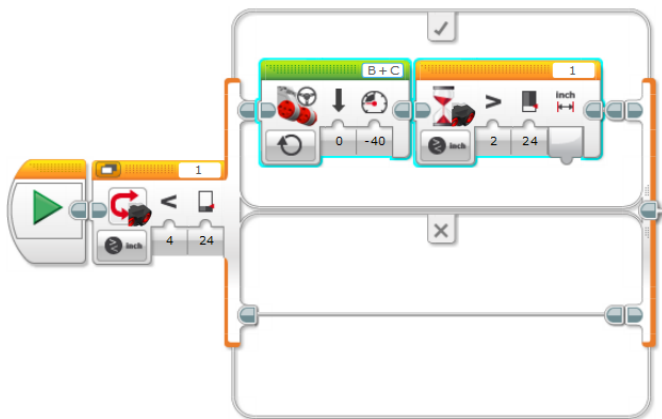

Programming with Switches (continued)

- If the condition specified is **not satisfied**, the program will execute the commands in the **bottom half of the switch**.
- This means the robot is more than 24 inches from the wall and we need the robot to go forward until it is closer than 24 inches from the wall.
- We can achieve this by using a forward move block with unlimited duration followed by a wait block as shown below.

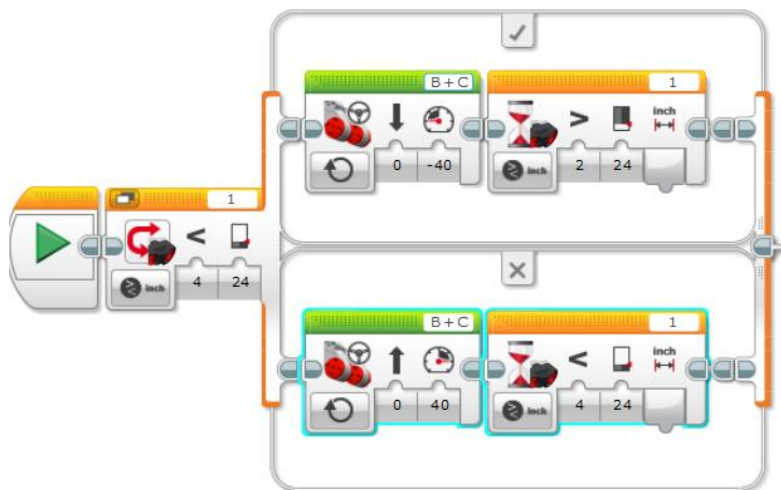

Mini-Activity 2

Do This:

- In worksheet Part 3, write out the program we just discussed in **WORDS**, that is, as an algorithm, and understand it fully.
- Then, write the EV3 program, download it onto the LEGO bevel and verify that it works correctly.

Note that all the blocks for this program are provided on the previous slides.

Mini-Activity 2 Programming Solution

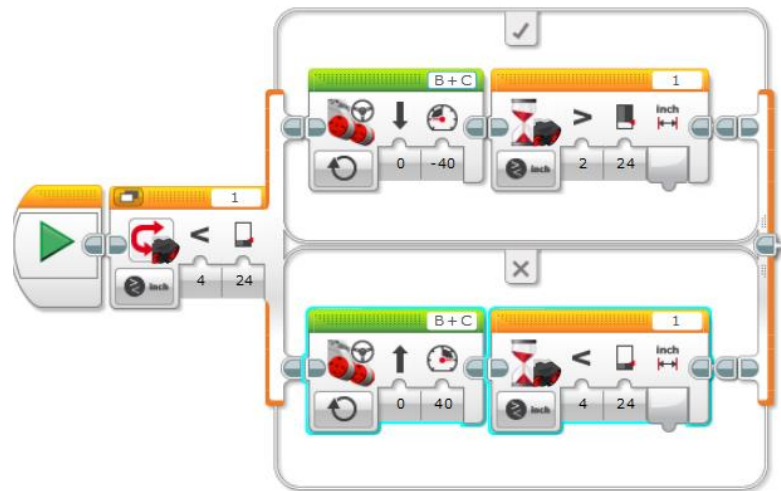

Loops and Switches Post-Quiz

1. What kind of blocks are these?

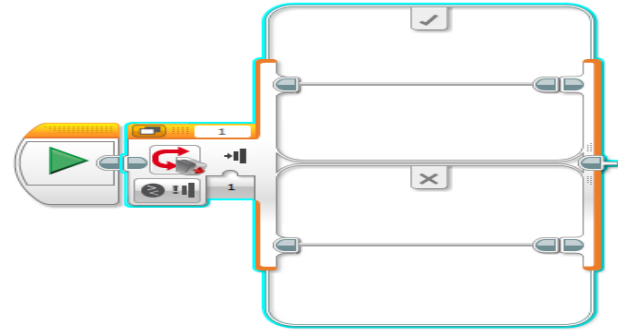
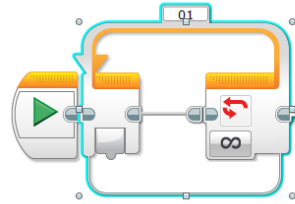

2. Name two kinds of controls that can be specified to determine how long a loop repeats.

3. Give an example of a program you could write that would use a switch.

Loops and Switches Post-Quiz **Answers**

1. What kind of blocks are these?

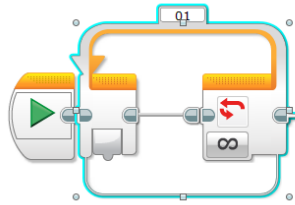

loop

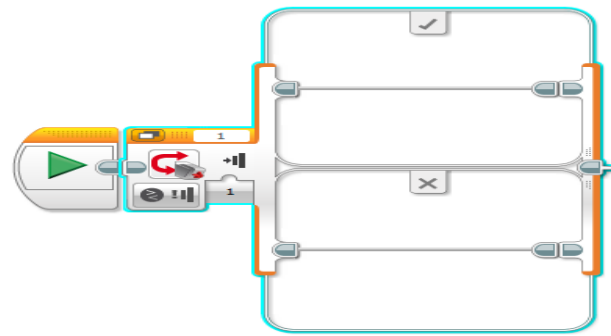

switch

2. Name two kinds of controls that can be specified to determine how long a loop repeats.

Any two of these: “Forever” (a never-ending loop), any sensor, “count” (tell the loop to repeat, for example, 5 times), “time” (tell the loop to repeat, for example, 1 minute), logic

3. Give an example of a program you could write that would use a switch.

Example answer: While the touch sensor is pressed, go forward otherwise move backwards.

Vocabulary

loop: A command or “operator” that repeats a set of commands.

switch: In programming, an object that gives different commands depending on which state it is in.

Images Sources

Slide 1: girl on floor with laptop; source: Microsoft® clipart: <http://office.microsoft.com/en-us/images/results.aspx?qu=laptop&ex=1#ai:MP900442369>

Slide 1: multicolored chevron loop; source: Microsoft® clipart: <http://office.microsoft.com/en-us/images/results.aspx?qu=cycle&ex=1#ai:MC910216324>

Slides 1, 14: wall switch drawing; source: Microsoft® clipart: <http://office.microsoft.com/en-us/images/results.aspx?qu=light+switch&ex=1#ai:MC900441745>

Device and programming images from LEGO MINDSTORM NXT User's Guide <http://goo.gl/wuhSUA>

Screen captures and diagrams by author