

Saltwater Circuit

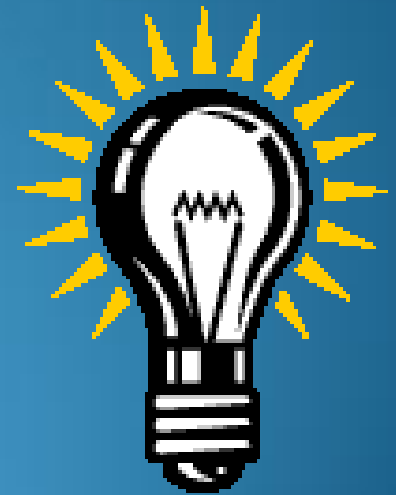

What is a saltwater circuit?

- It's an electric circuit that uses saltwater as one of its circuit elements.
 - When you mix water and salt, the salt dissolves. Salt turns into sodium ions and chloride ions.
- When you apply a electric voltage, the circuit conducts electricity if enough sodium ions and chlorine ions are present in the water.

Basic Circuit

- **Electric circuit:** A chain of connected circuit elements

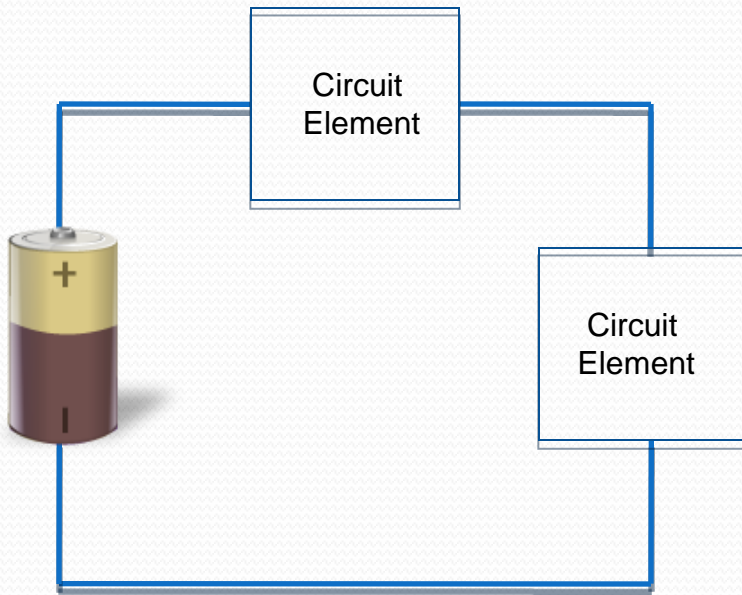

- **Closed circuit:** All circuit elements are connected and electric current flows through the circuit.

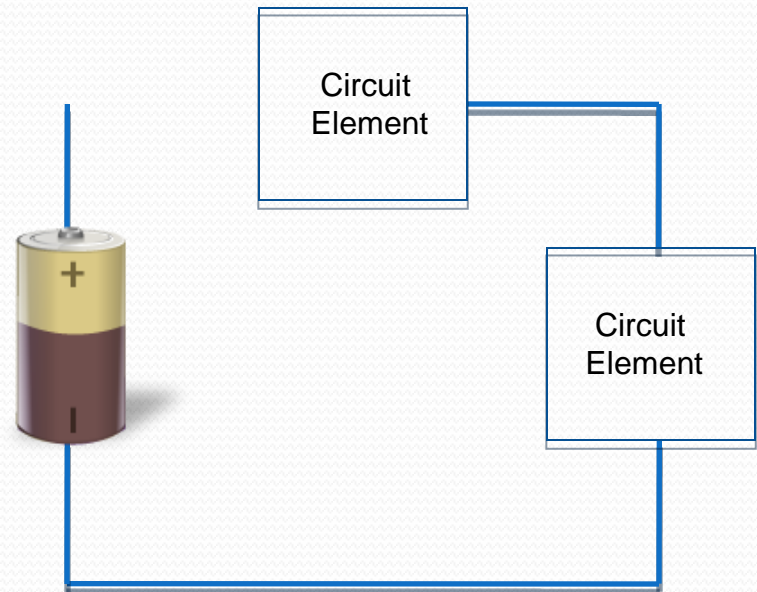

- **Open circuit:** At least one break in the circuit. Not all elements are connected. Electric current does not flow in the circuit.

Saltwater Circuit

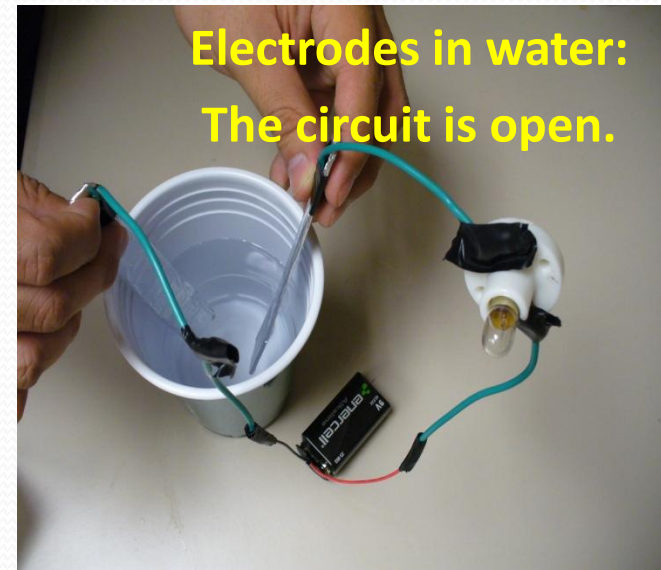
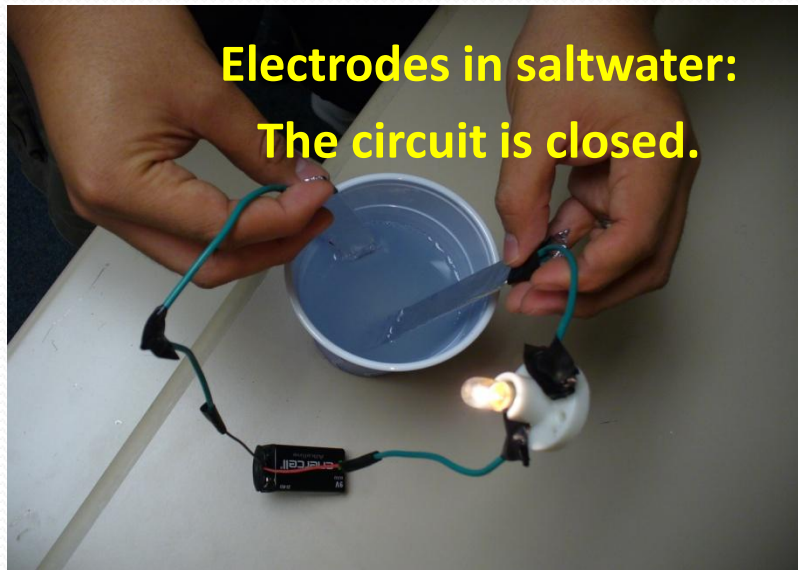
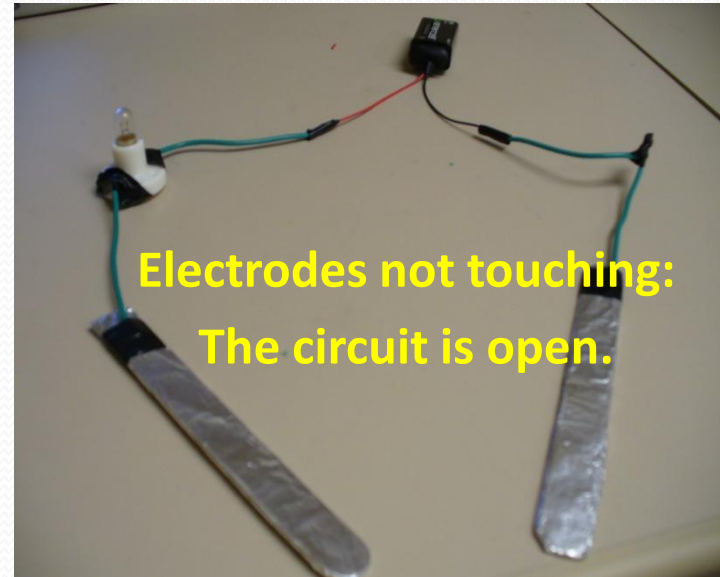
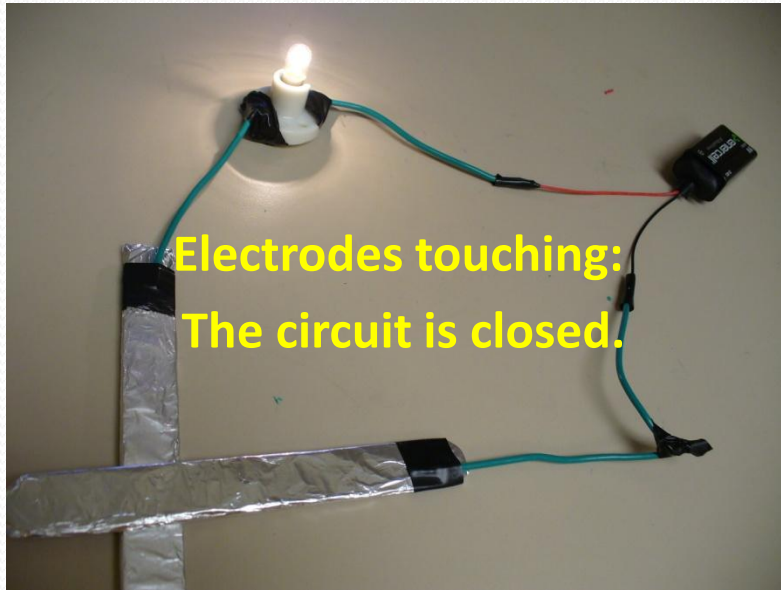

Your Objective:

Answer the following question:

- How does the quantity of salt in a saltwater circuit effect the current flowing through the saltwater circuit?

The end

References

- PBS Kids Go. Zoom-Saltwater Rocks. WGBH Educational Foundation. Accessed May 1, 2010. <http://pbskids.org/zoom/activities/sci/saltwatertester.html>
- Wikipedia.org, Wikipedia Foundation Inc., Accessed May 1, 2010. (Source of vocabulary definitions with some adaptation.) <http://wikipedia.org>

Image sources

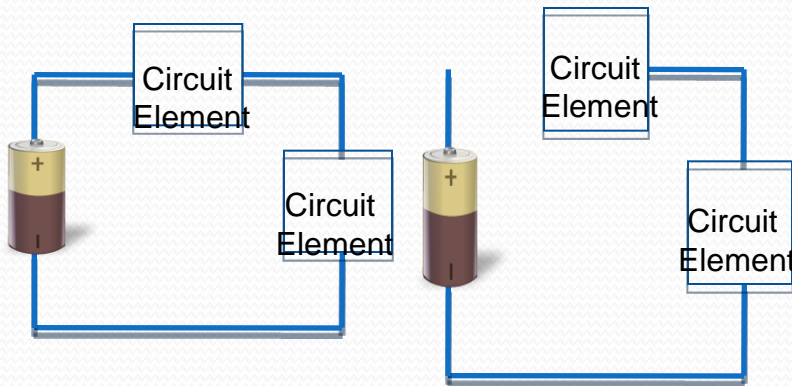

Diagrams by Juan Ramirez Jr.,
ITL Program, College of Engineering,
University of Colorado at Boulder, 2009



Battery image from Microsoft clipart



Light bulb image from Microsoft clipart

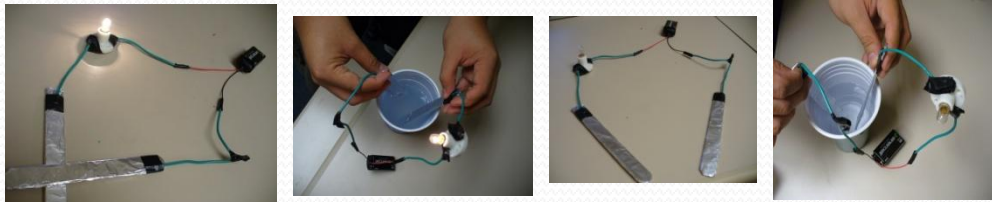

Photos by Juan Ramirez Jr.,
ITL Program, College of Engineering,
University of Colorado at Boulder,
2009