

What we're making today:

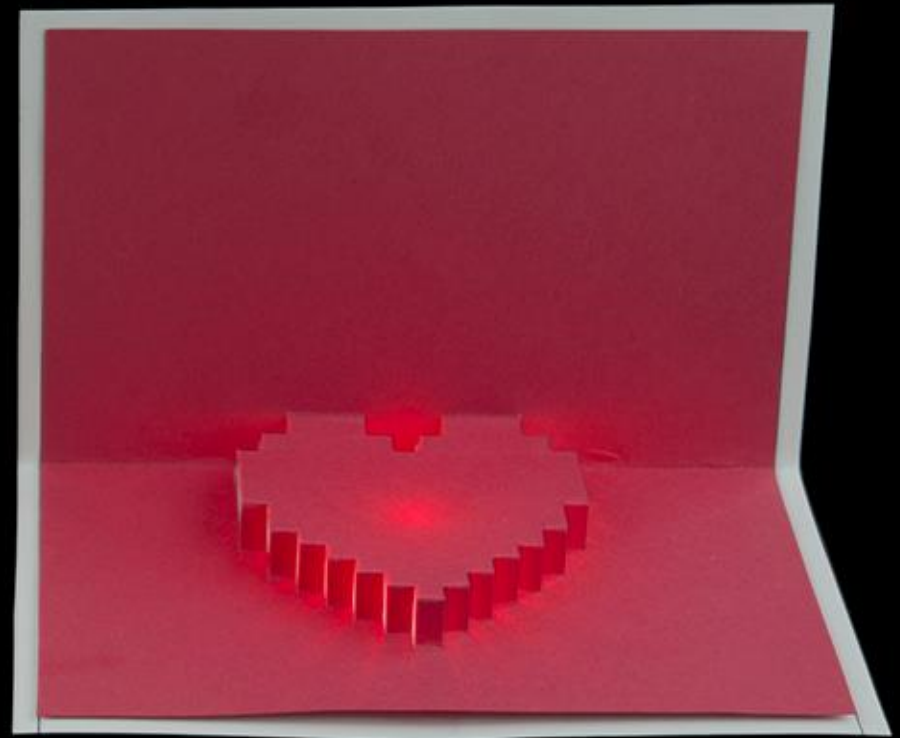

Light-Up Pop-Up Greeting Cards

Basic Circuit

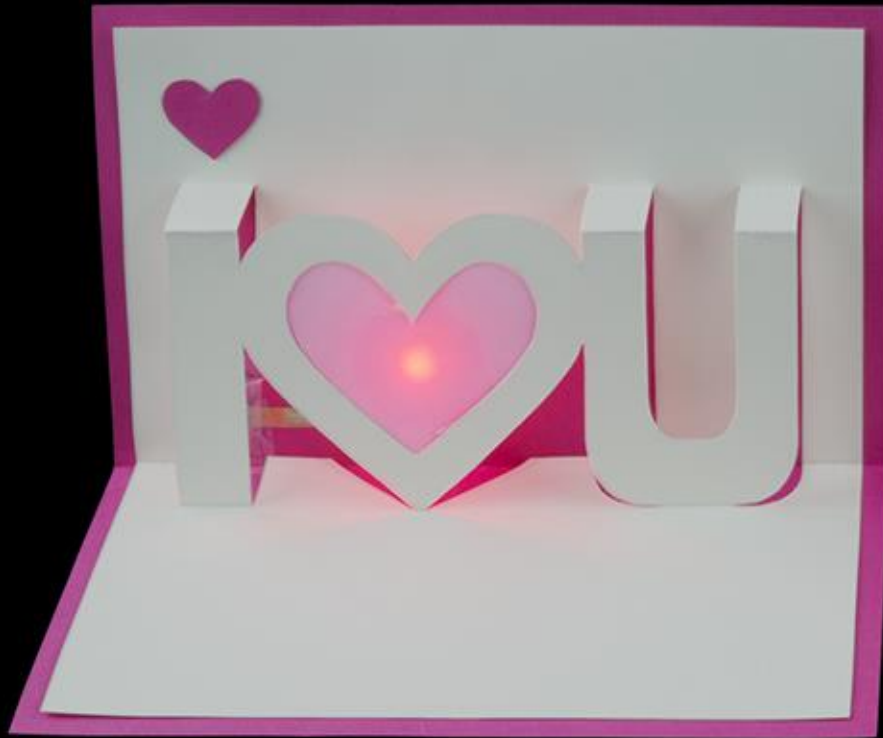
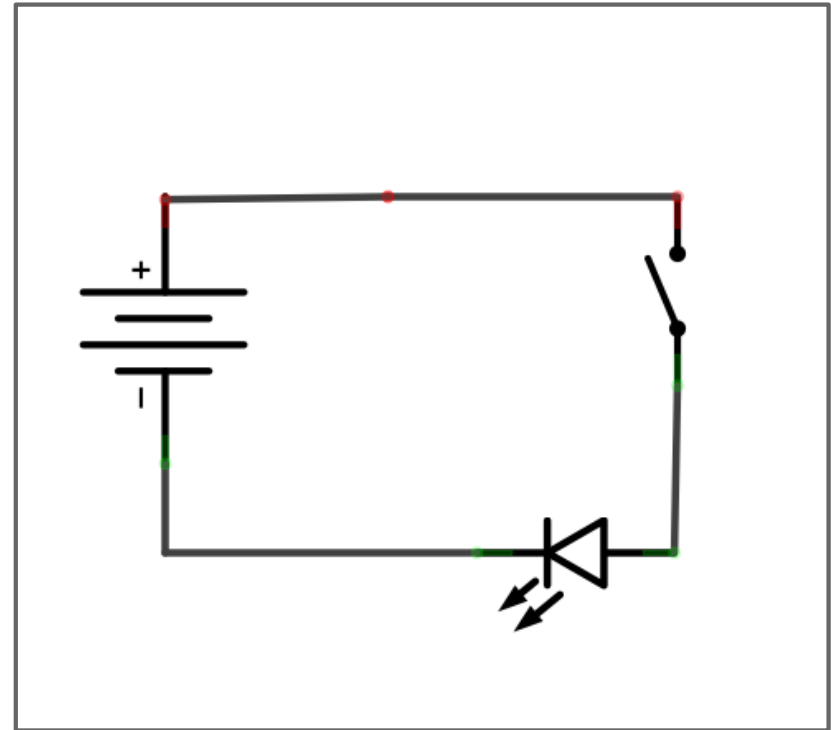
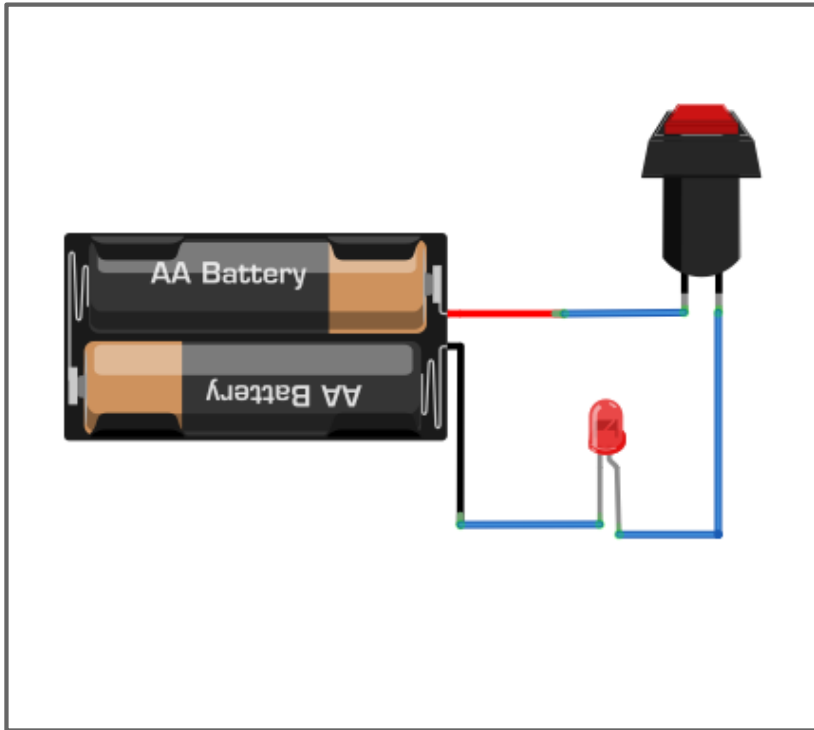

A circuit is the circular path that electricity flows through

An example completed paper circuit

Supplies:



5mm Copper Tape (~15 inches)



3mm LED



LilyPad Button Board



12mm Coin Cell Battery (CR1225)

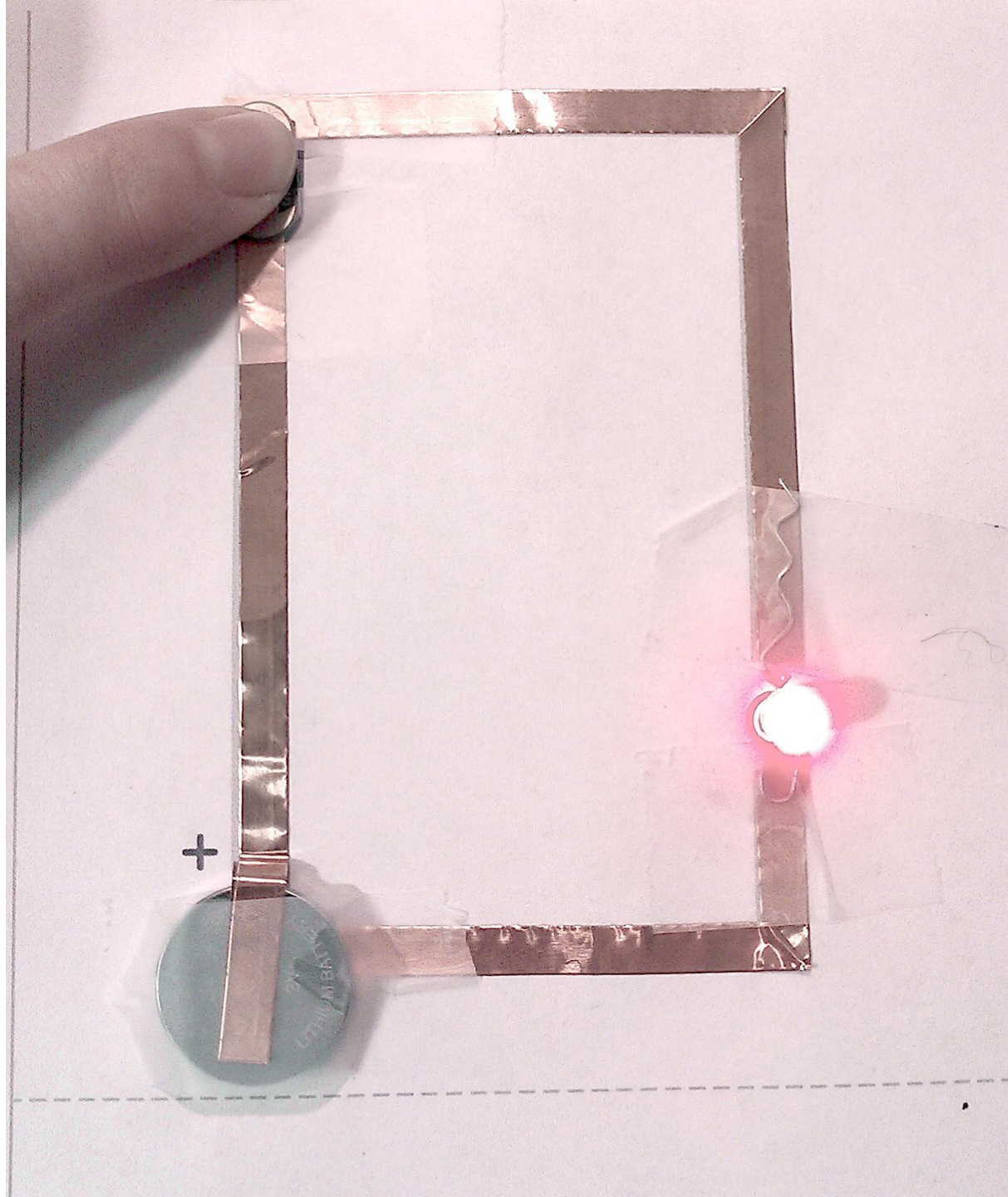

About Copper Tape

Pros:

- Nice and conductive!
- Peel and stick
- Can use conductive paint to attach components to it
- Can solder components to it

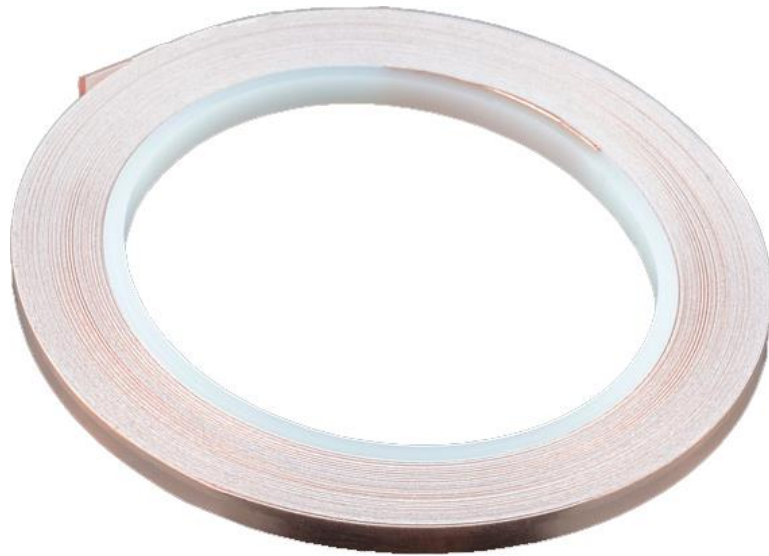

Cons:

- Needs a *continuous line* so you must get creative when turning corners
- Adhesive is NOT conductive
- Can have sharp edges so be careful!

Let's Get Started! Look at your template:

Start taping here

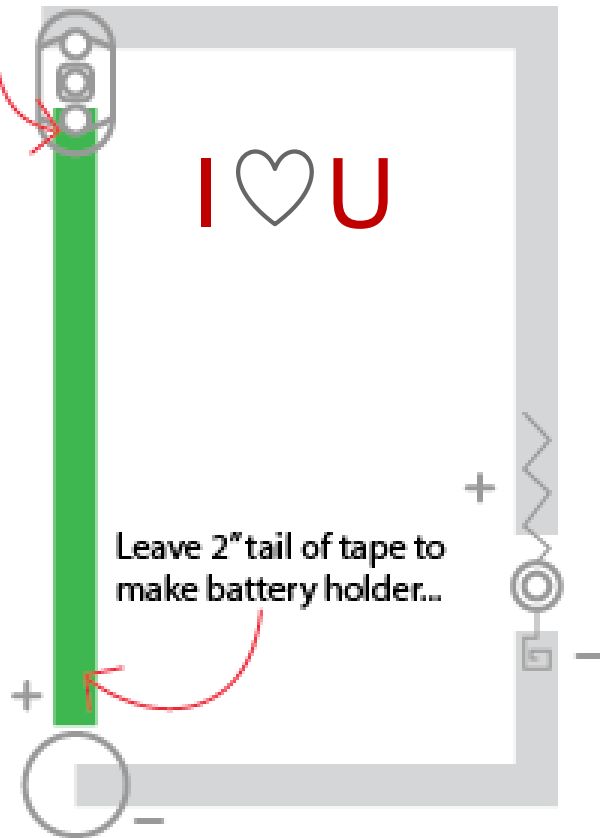

Leave 2" tail of tape to make battery holder...

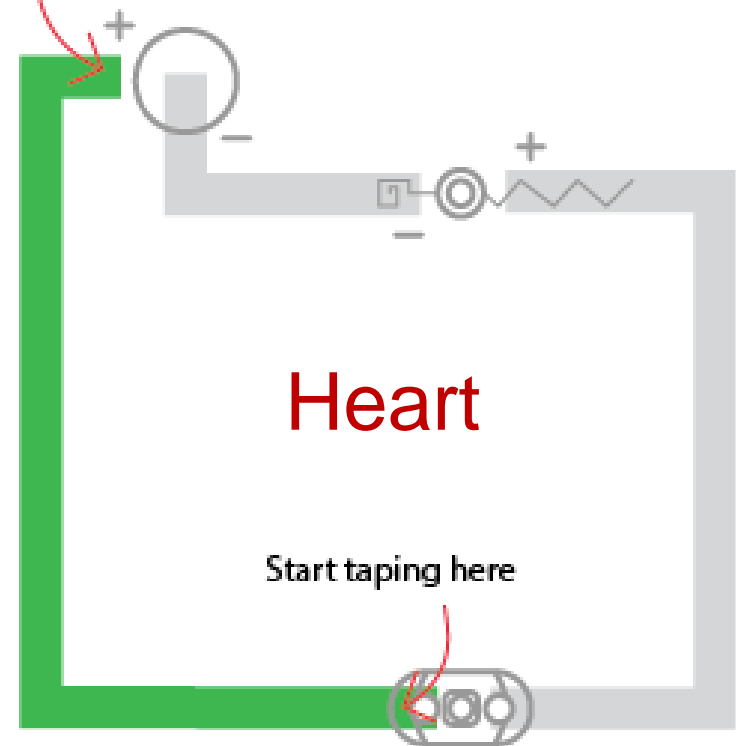

— CUT --- FOLD

 DISCARD

  Look for these icons

 COPPER TAPE

 LED

 BATTERY

 BUTTON

Turning corners with the copper tape

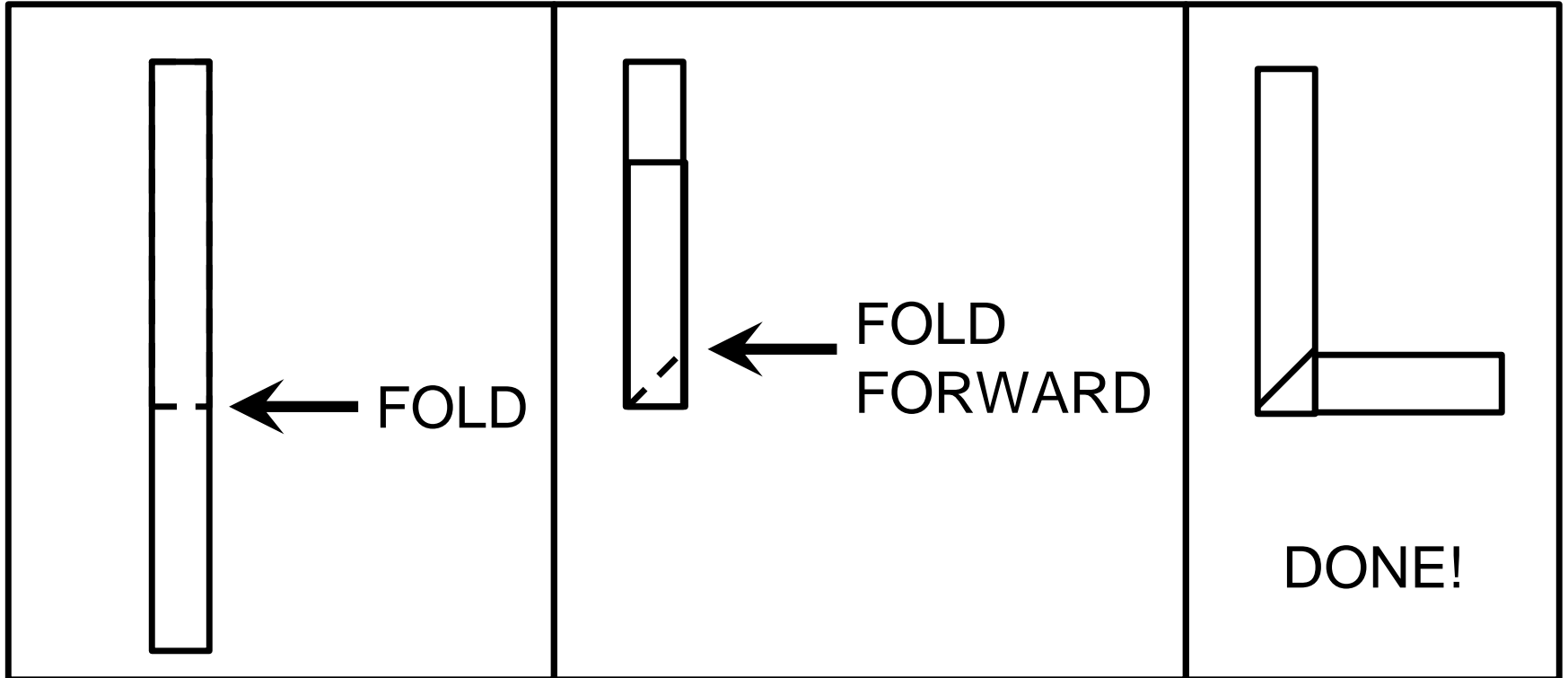

It's okay if your fold isn't perfect — we just want to go around the corner without the tape breaking

Joining tape in case of breaks/tears

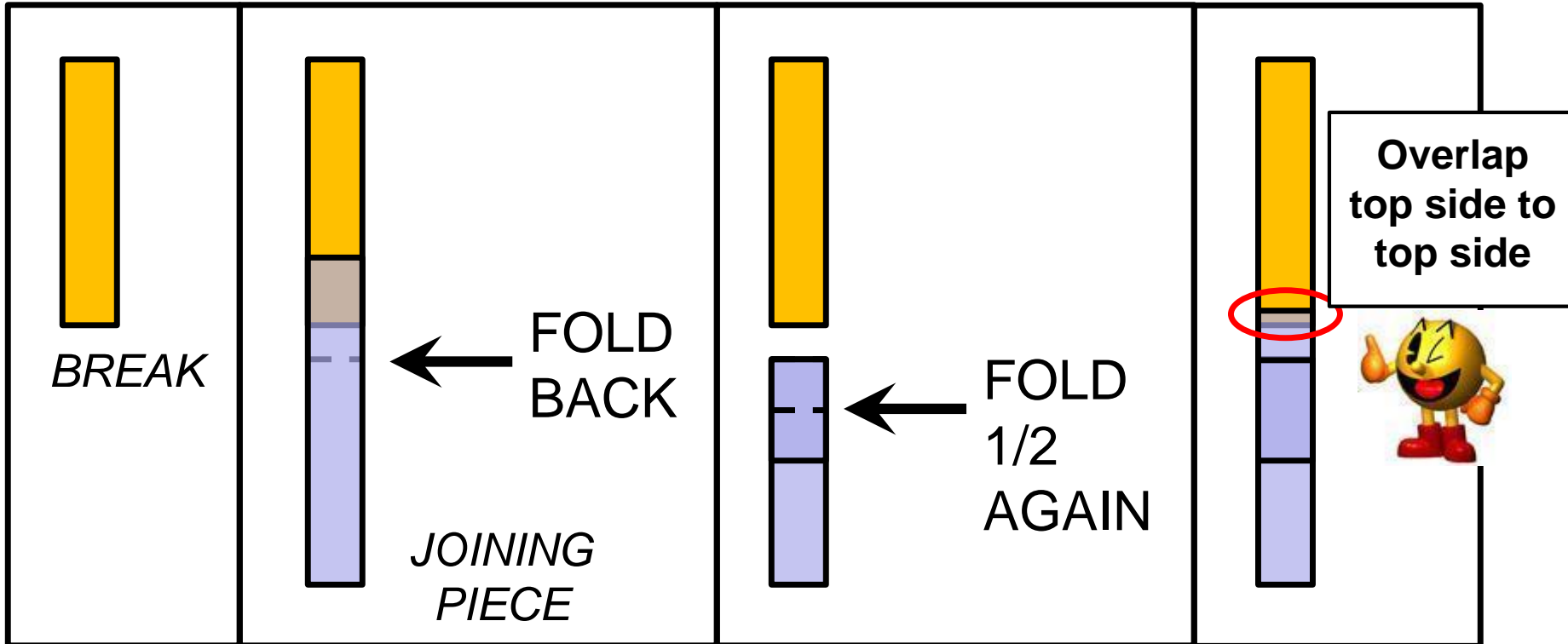

- Join pieces by touching the **TOP SIDE** of the copper tape to the **TOP SIDE** of each section
- **Secure with clear tape**

Making a Battery Holder

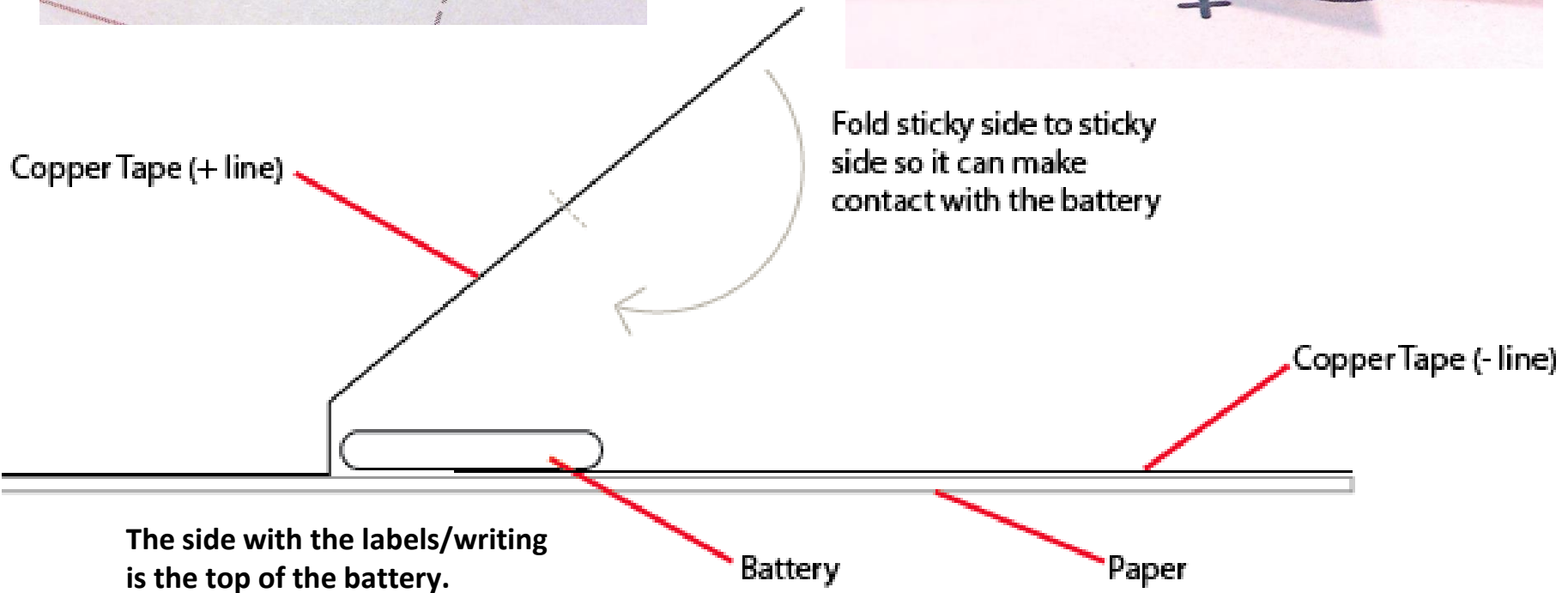
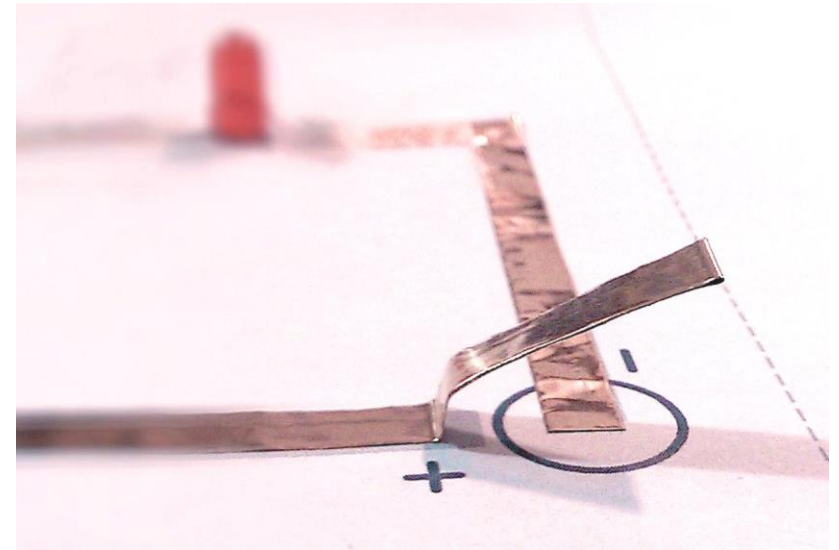
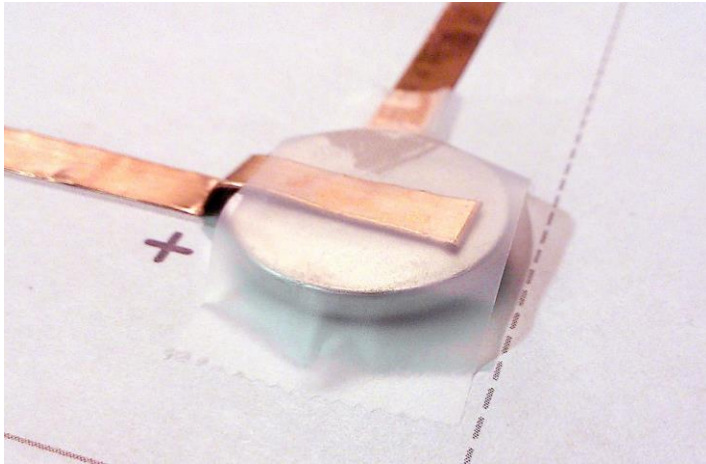

LEDs

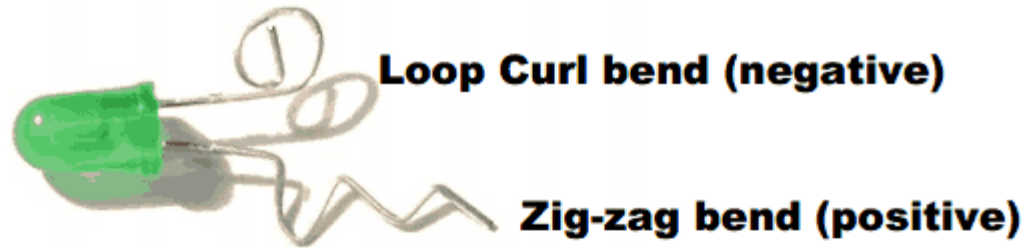

- Use clear tape to stick the LED to the copper tape
- Make sure the + and - are aligned correctly

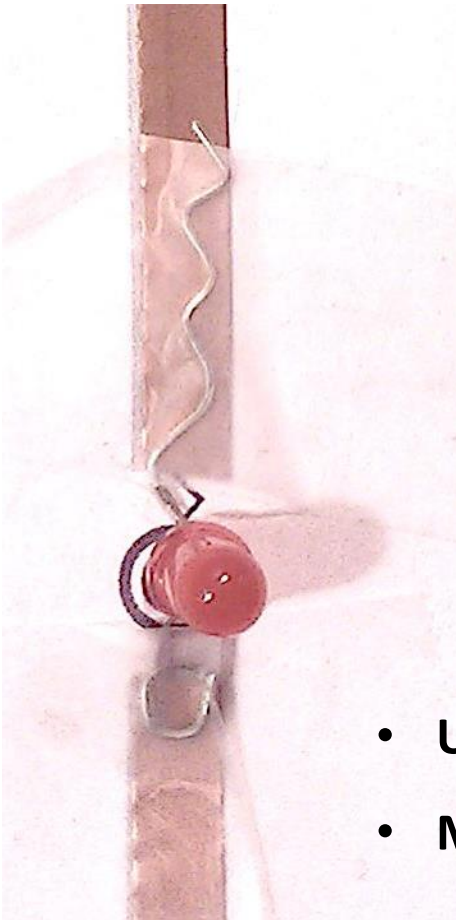

Add the LilyPad Button



Conductive pads



Try not to
tape directly
over the
push button

Keep to the
pad ends

Folding Tips

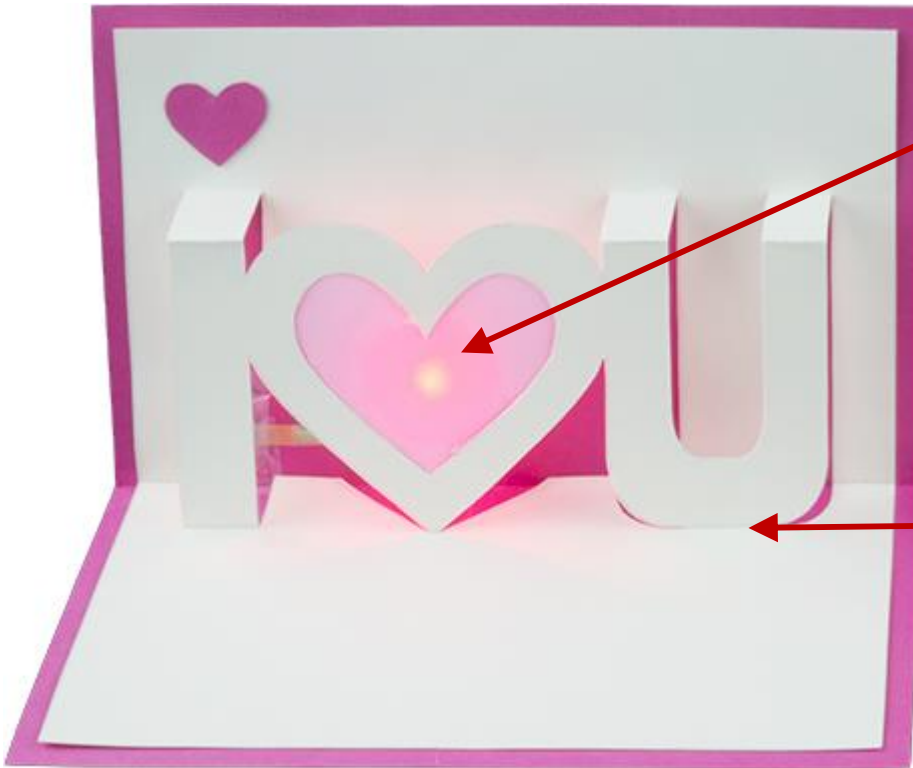

Cut some vellum that is a little bigger than the hole in the heart and paste/tape it behind the opening **before** you start folding

Push the bottom of the U or I letters down first and work your way up to the smaller folds

Folding Tips

This template is **tricky** and takes some **patience** to fold

Hang in there!

Hold the template upside down and start with the point of the heart

Use gravity to help you pull all the little folds up one by one

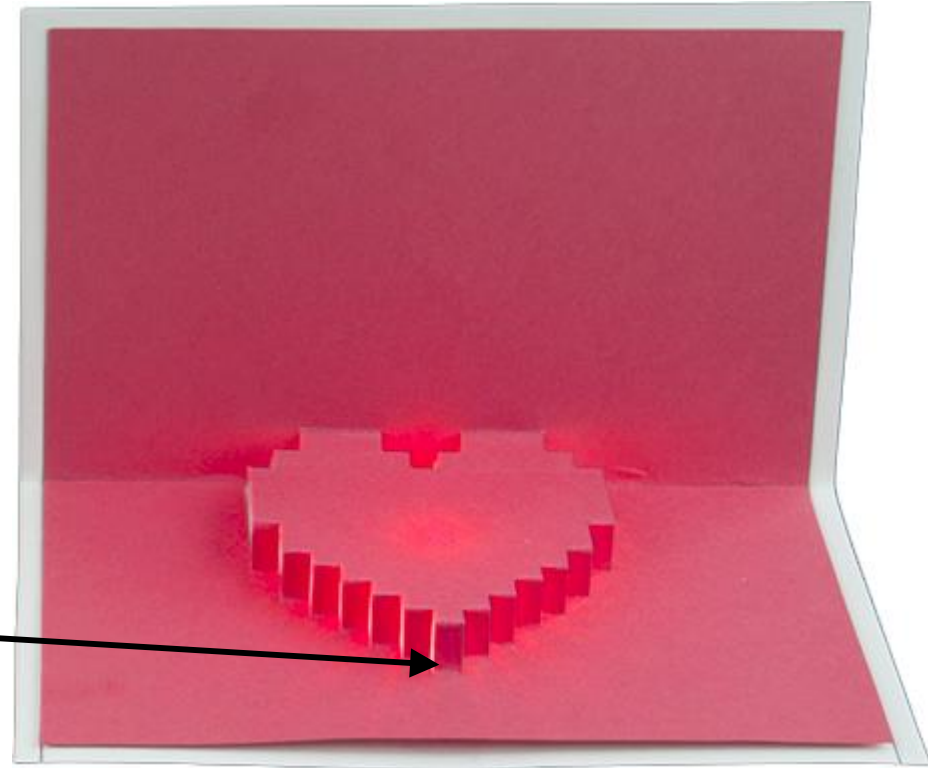

Add text or a symbol showing where to press

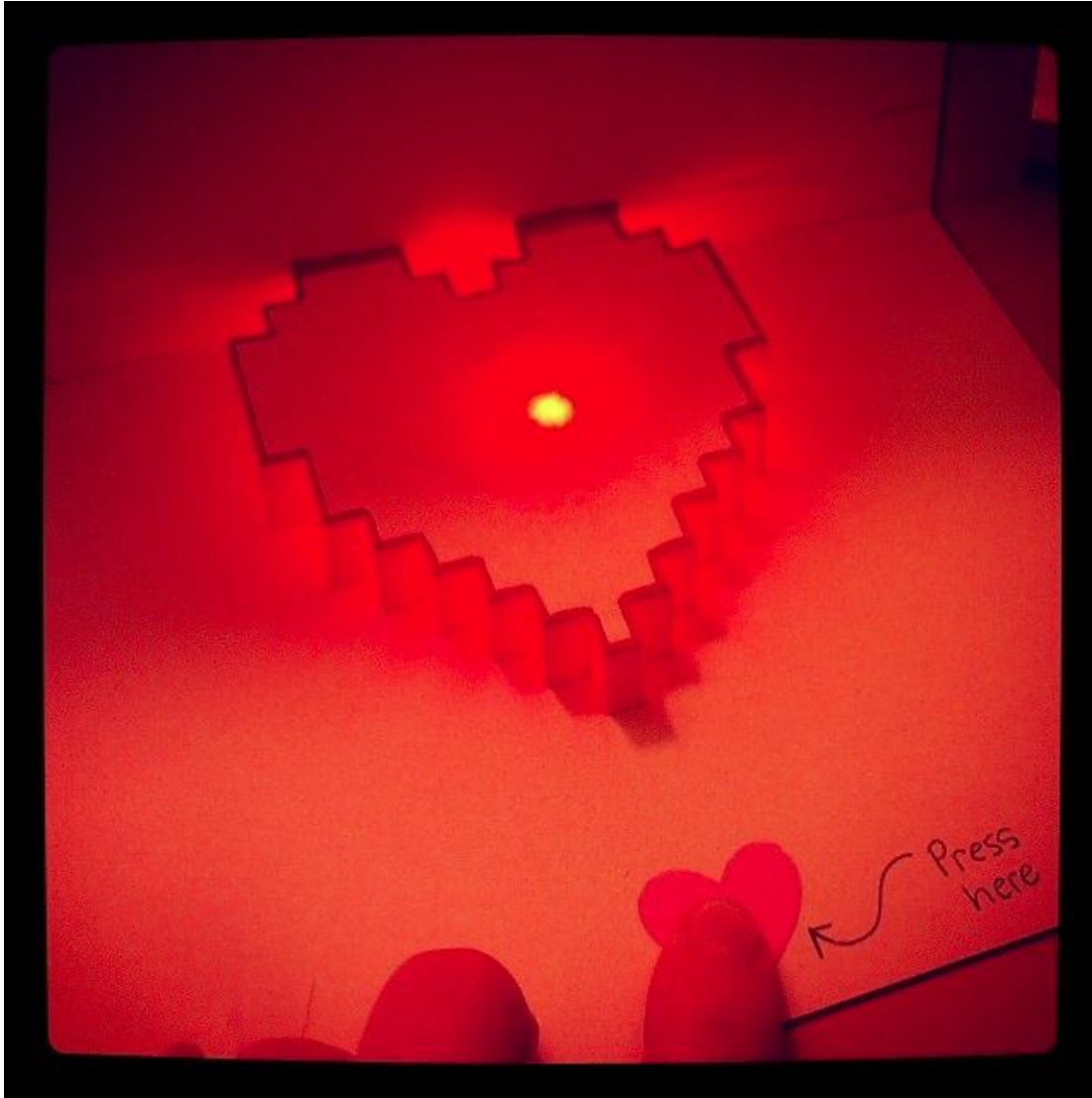

Press here ↓

If you are mailing your card, mark the outside envelope “**hand cancel**” so the LED won’t get crushed by sorting machines :)